



# AdventistSat.com

Adventist Satellite Ministry Support Services

Tel 916-677-0720 • Fax 916-677-6228  
8801 Washington Blvd., Ste. 101, Roseville, CA 95678

<http://www.adventistsat.com>

4.2006 Fortec Ultra.v4

## Important Notice to Installers

This equipment is preprogrammed to receive all Adventist Satellite Television and Radio Services. Please follow the Quick Guide instructions below. **Do not enter the Menus to view the Signal Quality.** Do not adjust or modify any menu item unless the equipment will be used to receive channels other than the preprogrammed Adventist services!

## Quick Guide for Installation: AMC4

1. Before assembling the satellite dish, lay the reflector on a flat surface and verify that the reflector has not been warped in shipping. If the rim edges do not lie flat, slightly flex the reflector until the edges lay flat.
2. Install the dish using the included dish aiming coordinates for AMC4 @ 101° West
3. Tune receiver to **3ABN** channel 6 (the strongest transponder)
4. Press **SIG** key on remote to display signal strength **Level** and **Quality** install screen.
5. Find satellite and peak **Quality** reading by adjusting dish and LNBF placement and rotation. Signal Level is not as important as the Quality reading, which must be at least 90 – 95%
6. Press **SIG** key to remove display
7. Place receiver on **LLBN** channel 5 (a weaker transponder)
8. Press **SIG** key
9. Peak **Quality** reading by fine tuning the dish angles and LNBF placement. Verify the Quality reading is at least 80%
10. Press **SIG** key to remove display
11. Installation is now complete.  
*(Note: Additional channels maybe added by performing a Satellite or Power Scan)*

AMC 4 Dish Aiming Information for Zip Code \_\_\_\_\_

Dish Elevation	____.____ °
Compass Reading	____.____ °
LNBF Rotation	____.____ °

## Technical Assistance

**916-677-0720**

8 am - 5 pm, PT, Monday – Thursday  
8 am – 4pm, PT, Friday  
[service@adventistsat.com](mailto:service@adventistsat.com)

To become a dealer of Satellite AV products:

1-888-483-4673  
<http://www.satelliteav.com>  
[sales@satelliteav.com](mailto:sales@satelliteav.com)



# AdventistSat.com

Adventist Satellite Ministry Support Services

Tel 916-677-0720 • Fax 916-677-6228

8801 Washington Blvd., Ste. 101, Roseville, CA 95678

<http://www.adventistsat.com>

## Do It Yourself Guide for Adventist Satellite Installation



System: Fortec Lifetime Ultra

### Table of Contents

1. Selecting the Best Dish Antenna Location
2. Installing the Universal Dish Post Mount
3. Assembling and Installing the Dish Antenna
4. Connecting the Satellite Receiver
5. Aiming and Fine Tuning the Dish Antenna
6. Completing the Installation
7. General Site Survey – Can I Receive the Adventist Channels at My House?
8. FAQ – Frequently Asked Questions and Troubleshooting
9. Site Check Elevation Angle Calculator

**Please read these instructions completely before attempting to install your system!**

If you feel comfortable with drilling holes in the walls and/or roof of your home, climbing ladders, attaching wires to the utility ground according to NEC and local codes and following step-by-step instructions, you might consider installing your own system. **The satellite is located over 23,000 miles away and the installation does require precise tuning and a great deal of patience to correctly install.** Have you recently installed a light switch, ceiling fan, basketball hoop and programmed a VCR? If not, this project might not be a good time to hone your mechanical and electrical skills!

**Please contact Adventistsat.com at 888-483-4673 or 916-677-0720 if you would like to schedule a basic professional installation in the US or CANADA.**

## 1. Selecting the Best Dish Antenna Location

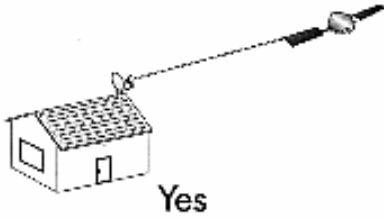

Using the aiming coordinates from the first page of this guide along with a compass and angle finder, locate a dish mounting position. While facing the direction of the satellite, reference the compass angle and elevation. The dish **must** be located with a clear line of sight to the satellite with no obstructions. Satellite signals will not pass through leaves, limbs, overhangs, glass, etc.

If no suitable location can be found on a wall or roof, consider alternative mounting locations such as setting a galvanized pipe set in cement located in a clearing. Do not mount the dish on a wooden post or high up on a tree, as this will not provide a stable platform.

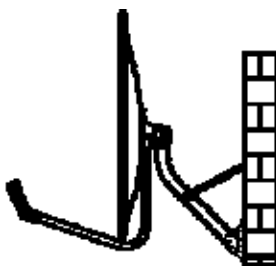

Wall Mount



Roof Mount



## 2. Installing the Universal Dish Antenna Post Mount

Secure the universal dish post to a wall or roof. Be sure that the lag bolts on the base plate are securely screwed into a rafter or wall stud and not only into the sheeting providing a solid base for the remainder of the installation. Level the mounting post using a level (two-way post levels simplify the installation process). The tripod legs must be used to secure the post mount before mounting the dish.

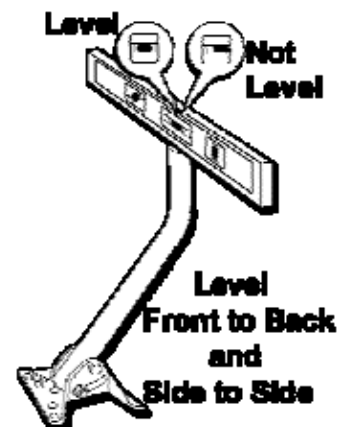
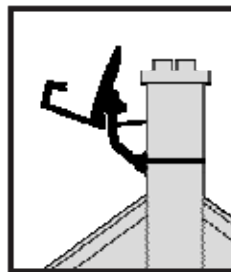
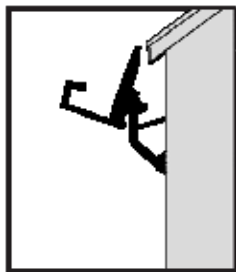
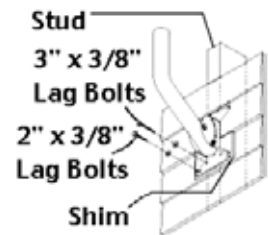

Failure to install the tripod legs will result in a collapse of the satellite dish in even light winds. The slightest movement of the installed dish and mount will result in degraded quality and loss of reception! Apply silicone caulking or other sealant to all lag bolts and cable access holes to prevent water leakage.

If the post is not level, aiming will be difficult!

### 3. Assembling and Installing the Dish Antenna

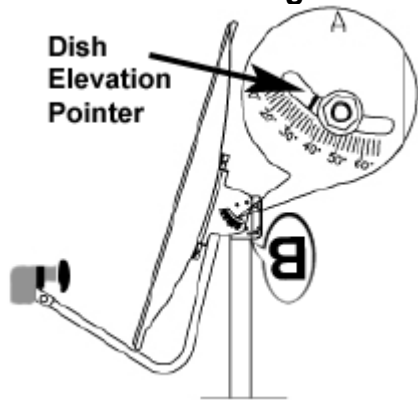

Most installations in North America will use **Elevation Scale A** located on the left side of the Elevation Bracket to set the dish Elevation Angle. Assemble the dish antenna using either the **A Type** configuration if the required Dish Elevation Angle is between 20 - 50 degrees or the **B Type** if the elevation is 50 – 90 degrees. The dish has been correctly assembled for Measuring the Dish Elevation Angle using the **A Scale** if an upside letter **B** is visible stamped on the Post Clamp. If an upside down letter **A** is visible on the Post Clamp, the dish has been assembled to use **Scale B** for measuring the Elevation Angle.

Adjust the Dish Elevation Angle to the correct setting using the pointer located beside the elevation fastening nut then semi-tighten. Place the dish on the mounting post and aim towards the Compass Reading using the included compass. Metal and electrical devices, including parts of the dish and mounts, will affect the compass readings. Be sure to take the compass readings at a distance away from these types of influences. Check this compass reading from several locations to ensure a correct aiming. Semi-tighten the Post Clamp fastening bolts to prevent the dish from freely rotating left or right.

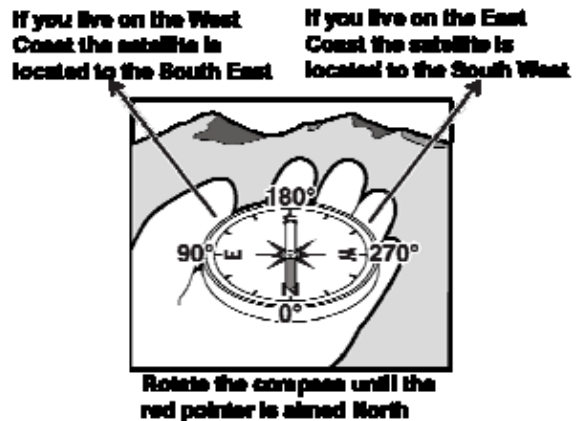

Attach the LNBF (small gray device with a white cap) to the LNBF arm of the dish. Set the LNBF rotation as specified in the aiming coordinates and slide the LNBF out away from the reflector then semi-tighten the set screws. Standing in front of the dish and looking towards the reflector, rotate the LNBF counterclockwise (left) if the LNBF Rotation is a positive number or clockwise (right) if the LNBF Rotation is a negative number.

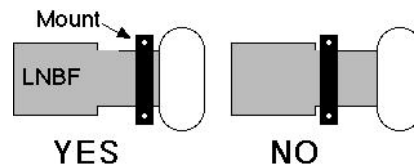
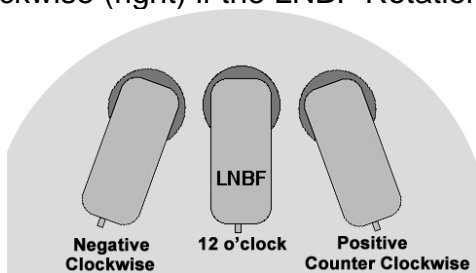

**Correct setting of the LNBF Rotation is critical to locating the satellite!**

### 4. Connecting the Satellite Receiver

The easiest way to aim the satellite dish is to temporarily place the satellite receiver connected to a small television at the dish antenna mounting location. **DO NOT ATTEMPT THIS IF IT IS RAINING OR THE GRASS IS WET.** Remove the satellite receiver and remote control from the packaging. Install the included batteries into the remote control. Connect a coaxial cable from the LNBF on the dish antenna to the **SAT INPUT** port on the back of the satellite receiver. (Do not connect Satellite dish to ANT INPUT, as this input is reserved for outdoor antenna or cable TV) Finger-tighten these connections. **Never use a wrench to tighten these LNBF connections as this can cause severe damage and void the warranty!**

Connect the included RCA AV cable (yellow / red / white plugs) between the satellite receiver and the TV and turn on the TV. *Optional: Connect a short coaxial cable from the TV OUT port on the back of the satellite receiver to the antenna input of the television then set the channel 3/4 selection switch on the back of the satellite receiver to an unused channel in your area (usually channel 3) and turn the television on and set it to the matching channel.*

Plug the AC power cable of satellite receiver into a surge protected power strip. Make sure, the Master Power switch on back of the receiver is turned on. The receiver will automatically power. Press the **Channel Up** or **Down Arrow** button to choose **Channel 6, 3ABN English** (this is the strongest channel on the satellite which will help you find the signal faster).

## 5. Aiming and Fine Tuning the Dish Antenna

Press the **SIG** button on the remote to display the signal strength screen which displays indicators of level and quality. When the dish is aimed correctly the **UNLOCK** indicator will change to **LOCK** and the **Quality Bar** will turn green and display a quality level.

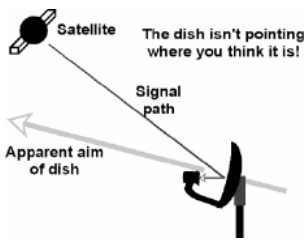

**Offset dish antennas are aimed at an elevation that is higher than the angle that the face is directed.**

While you or an assistant observe the quality meter, very slowly make small left or right adjustments. If necessary sweep the other direction until a green bar appears at any strength on the quality meter. Wait a few seconds between each adjustment to allow the receiver to process the information and update the strength and quality displays. If no green bar appears, adjust the dish up or down one degree of elevation and repeat the sweep process. When the receiver is connected to the dish, the strength level will display at least 50% signal. If the dish is aimed at the incorrect satellite, the meter will display a high signal, but the quality meter will never turn green. (HINT: Sweep extremely slow as a movement of just 1/2 of a degree can result in a perfect or no signal.) This process may need to be repeated many times in order to precisely aim and peak the quality of the signal.

Once the correct satellite is located, make small adjustments in elevation and direction until maximum signal is indicated on the quality bar. Quality readings should be 90% - 99% to insure optimum picture and sound on the receiver. The higher the quality, the better the reception. If the signal Quality is low the picture will break up into little squares and the sound will become garbled and choppy or will disappear completely!

Fine tune the installation by pressing the **SIG** button again to exit the signal strength screen then use the **Channel Down Arrow** button to select **Channel 5, LLBN**. Press the **SIG** button to display the signal strength meter and make small adjustments to the elevation and direction to peak the quality level. Tighten the elevation and post bracket nuts and bolts while continuing to observe the signal meters. If the signal quality drops during the tightening process, additional adjustments will need to be made. Peak the signal strength level and quality by slightly rotating the LNBF and / or moving the LNBF towards or away from the dish. Once the signal is peaked, tighten the LNBF mount bolt and screw. Press the **SIG** button to hide the signal strength meter. The dish installation is now complete.

### Scanning the Satellite for Additional Channels (optional)

If you would like to add additional channels, press MENU on the remote, then right arrow to enter the Installation menu. Now select **Power Scan** and press **OK**. Select **Satellite AMC4**, highlight **Scan FTA** and press the **OK** to begin satellite scan, this process will take approximately 10 minutes. After the Scanning is complete the receiver will restart and you may

begin viewing channels. *Do not* call to activate programming; all channels are free to air and available with no monthly charge. The receiver assigns channel numbers while scanning; therefore, no uniform channel line-up will be available.

## 6. Completing the Installation

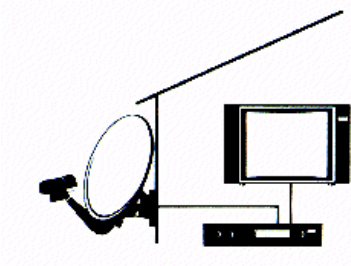

Carefully route the coax cable from the dish to the satellite receiver. Secure all cables using appropriate cable clips and nylon zip ties. Avoid using wire staples as they can dimple or penetrate the cable and can cause loss of signal! Do not tightly bend the cables and leave drip loops and cable loops as needed. Remember to seal all exterior wall and/or roof holes with a quality sealant or silicone caulking. Install the grounding block and grounding wire following all NEC and local electrical codes.



**Example of Grounding Block Installation**

**Important Notice:** We recommend that you do not use existing or pre-wired coaxial cabling. Always connect the RG-6 type coax cable directly from the satellite dish LNB through the grounding block and attach to the **SAT INPUT** connection on the rear of the Satellite Receiver. Do not use cable splitters or any other device in the coax line connecting the dish to the receiver unless approved for satellite installation. A single output LNB should only be connected to one receiver. Multiple receiver installations should use a multiple output LNB to avoid programming conflicts between the receivers.

**SEVERE DAMAGE COULD RESULT BY CONNECTING THE RECEIVER TO DEVICES OTHER THAN THE LNB.**

The basic installation is now complete. Connecting the satellite receiver audio outputs to the television, VCR and/or stereo inputs can enhance the audio. Connection of the video or s-video outputs to the VCR and/or television inputs will result in improved video! Consult the Fortec Lifetime Ultra owner's manual for additional operational information.

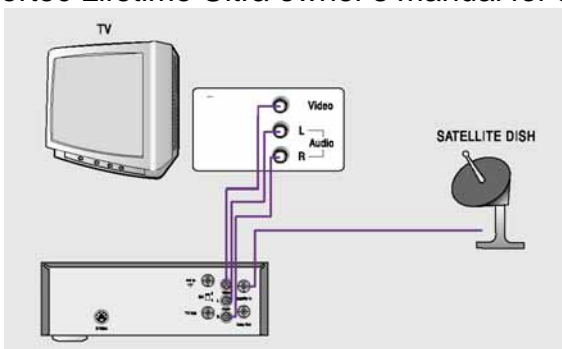

**Connection with RCA AV Cables**

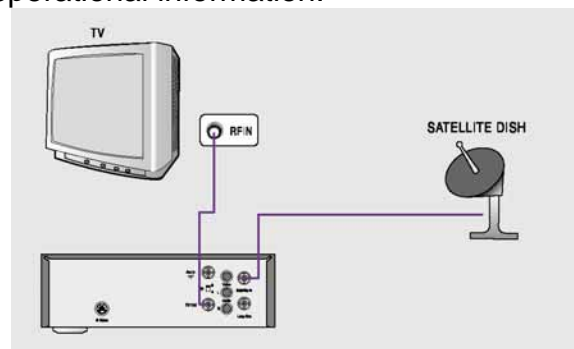

**Connection with RF Coax**

# Will a Hope Channel Satellite Dish Work at Your Home?

## 7. General Site Survey

To get a signal, the satellite dish must be pointed directly at the satellite, with NO obstructions between the two. This means NO trees and NO buildings. Take into consideration future tree growth, house remodeling or additions and new construction in your area.

**The satellite signal WILL NOT PASS through leaves or branches.**

**The satellite signal WILL NOT PASS through glass; don't try to install your dish indoors!**

## Where Is The Satellite, Anyway?

The satellite is always located south of Texas. That means if you live in Miami, you must have a clear line of sight to the southwest; if you live in San Francisco, you must have a clear line to the southeast.



## How High Up in the Sky is the Satellite?

Depending on where you live, the satellite will be at an elevation angle between 30 and 60 degrees. Southern US point more toward 60 degrees; northern US point more toward 30 degrees. The average elevation is 45 degrees.

Northern Canada, Alaska and Hawaii elevation angles can be very low on the horizon. Please call (888) 483-4673 if you require aiming assistance.

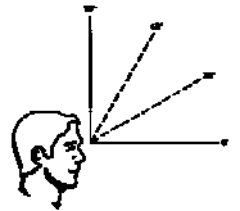

## Finding a Clear Line of Sight

1. Go outside and locate at least one site on your property that has a clear view to the satellite. You should be reasonably certain you are pointing towards Texas (unless you're in Texas, in which case you should be looking due south). You may want to use a map.
2. Imagine an arc ranging from 30 to 60 degrees above the horizon.
3. Do you have at least one clear view to the satellite? Remember, no trees, leaves, buildings, or windows can be between the dish and the satellite.

If the answer is **NO**, your site may be unsuitable for installing the satellite system.

If the answer is **MAYBE**, you may want to contact the technical department at (888) 483-4673 for information about having a professional installer conduct a thorough site survey.

**If the answer is YES, your site should be suitable for installing the system.**

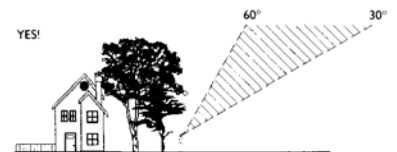

## 8. FAQ – Frequently Asked Questions and Troubleshooting

### **Satellite receiver displays “Scrambled / No Signal” and audio may be present.**

Reset the Master Power switch on rear of receiver.

### **Remote doesn't work but receiver front panel buttons may turn on/off and change channels.**

Check batteries, remote needs clear line of sight to the receiver. Reset Master Power switch.

### **Are more channels available?**

Many more channels are available for viewing on this and other satellites. This receiver is capable of automatically programming these additional TV and Radio services. Many free national and international services are available. *Do this at your own risk, as AdventistSat.com will only provide the two-year free technical support for the reception of Adventist programming.* To receive additional programming from the AMC4 satellite you may use the power scan feature. Press the **Menu** key to enter the User Setup Menu then the **Right Arrow** to select the Installation Menu. Press the **Down Arrow** 4 times to select POWER SCAN then press **OK**. Press the **Up Arrow** to select SCAN FTA then press **OK**. The receiver will scan the satellite for new channels and automatically save them.

### **The receiver displays strong Signal Strength Level, but has no Quality on all channels.**

The dish might be pointed at the wrong satellite or there is an obstruction in the line of sight between the dish and the satellite. Mounting mast may have moved or is loose. Reset Master Power switch.

### **The picture breaks up into big blocks and the audio is garbled.**

The antenna might not be aimed correctly. Satellite view partially obstructed. Damaged coax or connections.

### **The meters display 20 percent signal level and no quality.**

Coax not connected from LNBF on dish to SAT INPUT on receiver. Bad coax, connectors or LNBF.

### **No lights on receiver.**

Check power plug make sure that it is plugged into an electrical outlet. Reset Master Power switch.

### **Satellite receiver has a channel number on front panel, but TV displays snow.**

Tune TV to channel 3 /4 or the AV input if using the RCA AV cables.

### **Local or cable TV channels are fuzzy and channel number is displayed on front panel.**

Turn off the satellite receiver when watching local or cable channels.

### **No audio on any satellite channels.**

Set satellite remote control audio up to 75% and use TV volume control to change volume.

### **Satellite receiver displays “No Signal” only during very hot or cold weather.**

LNBF is aging and is affected by temperature extremes. Replace the LNBF.

### **Picture breaks up during rain and snow**

Heavy rain or clouds may affect the strength of the satellite signal. A properly installed dish will rarely lose signal during extreme weather. Snow or ice build up can interfere with the satellite signal. Mount the dish where snow can be gently brushed off. Dish covers and heaters are available for locations with regular ice and snow accumulations.

### **Most of the channels have strong Signal Quality, but LLBN signal quality is poor or the receiver displays “No Signal”.**

LLBN has a weaker signal than the other Adventist channels and may display a low signal quality or no signal. Installations often need to be fine tuned to receive this weaker station. Place the receiver on the LLBN channel. Press the SIG key and make slight adjustments to the antenna elevation, azimuth and the LNBF rotation and distance from the reflector to peak the quality.

# Site Check Tool

## ANGLE FINDER

1. Print Angle Finder
2. Fold Angle Finder Outside Edges
  - Use Guide Arrows
  - Fold in Order 1, 2, 3 & 4
  - Use Tape To Secure Folds
3. Follow Printed Instructions

